

Operating Instructions

Appliances Serie 2300



Originalanleitung
 Notice originale
 Original instructions



Anleitung vor
 Gebrauch lesen!
 Lire la notice d'utilisation
 avant l'emploi!
 Read instructions before use!



Datum	08.08.2022
Ersetzt	17.11.2021
Verfasser	VAE
PL	KOM
Verantwortlich	VAE
Dok-Nr.	X101923E
Revision	2
Seiten	28

1 Safety instructions



Observe the notices **WARNING**, **CAUTION** and recommendations. Please follow the cleaning and maintenance instructions. These contribute to the proper functioning of the appliance.

1.1 General

Setting up, connection and first operation of appliances may only be carried out by **concessionary specialists** and **personnel authorized by ELRO**. **Installation and Initial Operating Instructions** must be read beforehand. Careless handling may cause burning or scalding due to:

- ⇒ hot surfaces
- ⇒ escaping steam
- ⇒ food that overflows



In case of malfunction or damage, do not put the appliance under pressure. The appliance should not be used as fryer => danger of fire!



Do not open the drain valve until the pressure has dropped to near atmospheric pressure.



Caution, hot surface!



Caution, hot surface that must be touched! Use all operation elements with the foreseen handle.



Caution, escaping steam! Steam can escape from all appliance openings.



Caution, danger of pinching or crushing!



The appliance must always be operated under supervision. Exceptions are the operation modes with “moist heat” and with “slow overnight cooking at low temperature”. The Appliance can be switched off for unintended functions, using the switch off button  at the bottom left.



Do not move the mobile appliance when it is full.



Safety devices must be checked for proper functioning at regular intervals by ELRO customer service.



Observe the filling mark!

Inappropriate use (filling food over the filling mark  or at 100% output in the continued





Shallow float-frying^{*)}



cooking phase) is dangerous and can cause scalding from hot food that spills over the side of the appliance.

In the operation mode shallow float-frying^{*)}, observe the min. and max. fat filling marks. Add fat when the level is below the min. fat filling mark, to avoid a fire hazard. The following marks are engraved inside the basin:

-  max. filling mark
-  max. fat filling mark ^{*)}
-  min. fat filling mark ^{*)}

The appliance must be installed with a distance of at least 900mm to devices that contain water. If this is not possible, splash protection with a height of at least 350mm must be installed.

Never add water to hot fat. Fat can ignite immediately ⇒ danger of fire!

Only use fire extinguishing equipment including manufacturer's proof that this equipment can be used to extinguish fires caused by oil and cooking fat.

The mobile appliance may not be moved when it is full.

The condition of safety equipment must be checked by ELRO After Sales Service in regular intervals.

Shallow float-frying^{*)}: Never close the appliance lid in this operation mode! If the lid is closed unintentionally, please open the lid carefully as hot fat and oil vapours are released! Fire hazard! For tilting appliances, fat must be drained with the ELRO drain valve when it is cold.

Lower and raise baskets slowly to avoid spilling of hot fat.

Fire hazard! Always use fresh fat. Old fat has a lower ignition point and promotes foaming over.

Food that is too wet, or in large quantities has an influence on foaming over of fat ⇒ danger of burning! Adding food that contains water causes a high risk of fat splashing.

The operation Autolift, Autolift-Pastamat, Autolift-Frittomat is suitable for batch operation. Load the corresponding baskets into the basket holder and

confirm with . The baskets are lowered into the

 **CAUTION**

 **CAUTION**

 **CAUTION**



cooking chamber, the set time begins to elapse. When the set time has elapsed, the Autolift lifts the baskets out of the cooking chamber. The horn sounds and the display blinks.

High-speed: Scalding by steam! Never touch  when loading or unloading the cooking chamber. Never open the lid during a process.

Only new, detachable hose sets enclosed with the appliance delivery may be used for connection to the water supply system. Old hose sets that have already been used must not be reused.

To avoid a hazard due to an unintentional reset of the safety temperature limiter, the appliance must not be supplied by an external switching device such as a timer, or be connected to a circuit that is regularly switched on and off by a device.

Always add dissolved salt to cooking water, and/or stir until all the salt has dissolved.



Preheat the appliance in dry condition (Preheating).

Add fat when the set-point temperature is reached. Before frying for the first time, the entire frying surface must be covered with fat..



For best frying results, arrange the food to be cooked from the middle to the outside of the pan.



Season food after roasting



High-speed*) mode is ideally suited for preparation of meal components. The High-speed function increases production output.

1.2 Manufacturer

E L R O

Wohlerstrasse 47
CH-5620 Bremgarten
www.elro.ch

1.3 ELRO After Sales Service











+41 (0)56 648 94 11







cs@elro.ch

Contents

Page

1	Safety instructions	2
1.1	General.....	2
1.2	Manufacturer	4
1.3	ELRO After Sales Service.....	4
2	ELRO Appliances Serie 2300	7
2.1	Area of application.....	7
2.1.1	Intended use.....	7
2.1.2	Not intended use	7
2.1.3	Noise emissions	7
2.1.4	IP Code	7
3	Appliances overview	8
4	ELRO Quick Cook Select QCS	9
4.1	Main Menu – Operation Modes – Work and Setting Ranges	9
4.1.1	Working with the QCS	10
4.1.2	Temperature	11
4.1.3	 Time	11
4.1.4	 Boiling level – Operation mode cooking	11
4.1.5	 Optitherm.....	11
4.1.6	 Start time.....	12
4.1.7	 WDS Water dosing system*)	12
4.1.8	 Core temperature probe*)	12
4.1.9	 Autolift*) – Autolift Fritomat*) – Autolift Pastamat*)	12
4.1.10	Procedure Vital pressure cooking with/without High-speed*)	13
4.1.10.1	Aborting a cooking process.....	13
4.2	 Basic preparation modes in the ELRO QCS cookbook	14
4.2.1	Create, Editing and saving cooking programs	14
4.3	Chef to Chef	15
4.3.1	Slow overnight cooking	15
4.3.2	Cooking with Optitherm.....	15
4.3.3	Standard cooking times.....	16
4.3.4	Production capacity.....	17
4.4	ELRO Drain valve.....	18
4.4.1	Cleaning	18
4.4.2	Maintenance.....	18
4.5	ELRO multifunction valve.....	19
4.5.1	Cleaning	19
4.5.2	Cleaning	19
4.6	ELRO safety lock system	20
4.6.1	Cleaning	20
4.6.2	Maintenance.....	20
4.7	 Autolift*).....	21
4.7.1	Batches	21
4.8	Tilting*).....	22
4.9	ELRO PMS, Power Management System	22
4.10	Power limitation system LBS*) on site	22
4.11	Mobile appliance*).....	23
4.11.1	Initial operation	23
4.11.2	Connection	23
4.11.3	Disassembly	23
4.11.4	Cleaning	23
4.11.5	Maintenance.....	23

4.12	Filter control ^{*)}	24
4.12.1	Filter factory setting.....	24
5	Cleaning	24
5.1	ELRO High Pressure Cleaning HPC.....	24
5.2	Long non-use	24
6	 Contact  Information  Settings	25
6.1	Contact - SW and HW, Software key.....	25
6.2	 Information – Appliance information	25
6.3	Settings – User code.....	26
6.3.1	 Preheating.....	26
6.3.2	Signal	26
7	Maintenance	27
7.1	Filter capacity	27
7.1.1	Filter replacement.....	27
7.2	Calibrate Water Dosing System WDS ^{*)}	28
7.3	Error Message.....	28
7.3.1	Finding errors, error diagnosis and repair.....	28

^{*)} Optionen

2 ELRO Appliances Serie 2300

Congratulations on your purchase of an ELRO series 2300 pressure bratt pan.

We are sure that this appliance will satisfy all your requirements in your daily kitchen operations. Please read these operating instructions carefully. Options are designated with a *) in this instruction manual.

2.1 Area of application

This appliance is intended for use in the following customer segments:

- ⇒ Homes, schools, boarding schools
- ⇒ Homes for the elderly and nursing homes, care centres
- ⇒ Catering and delicatessen companies
- ⇒ Regional hospitals, clinics and institutions
- ⇒ Military barracks
- ⇒ Personnel restaurants, central kitchens
- ⇒ Gastronomy, hotels
- ⇒ Cruise ships, shipping companies
- ⇒ Airline catering

2.1.1 Intended use

The ELRO series 2300 appliance is intended for food preparation and processing.

It is used as a modern and universal pressure cooker and offers the following advantages:

- ⇒ Roasting
- ⇒ Pressure cooking
- ⇒ Balanced pressure cooking
- ⇒ Steaming
- ⇒ Shallow float frying*)

This appliance is used by **trained personnel** in professional kitchens.

Use in vehicles, on ships or airplanes requires the authorisation of the manufacturer.

2.1.2 Not intended use

All other types of use do not correspond to the intended use and can be dangerous for people and/or goods.

In particular, no products that ignite below a temperature of 120°C or that may give off

- ⇒ toxic vapours
- ⇒ corrosive vapours

may be used.

This appliance may not be used by persons (including children) with limited physical, sensory or mental abilities, or lack of experience, and/or lack of knowledge. Exception: they are supervised by a person responsible for their safety, or have received instructions from this person regarding the use of this appliance. Children must be supervised at all times.

2.1.3 Noise emissions

Taking into account the machine noise information decree of 18th January 1991, this appliance is a technical working device which does not cause noise or in exceptions does not exceed a noise level of 70 dB (A).

2.1.4 IP Code

The series 2300 appliances have an IP code IP6 and IPX9k and are suited for high pressure cleaning. Please note that a kitchen may have appliances that have a lower IP code, and which could be damaged when using a high-pressure cleaner.

3 Appliances overview

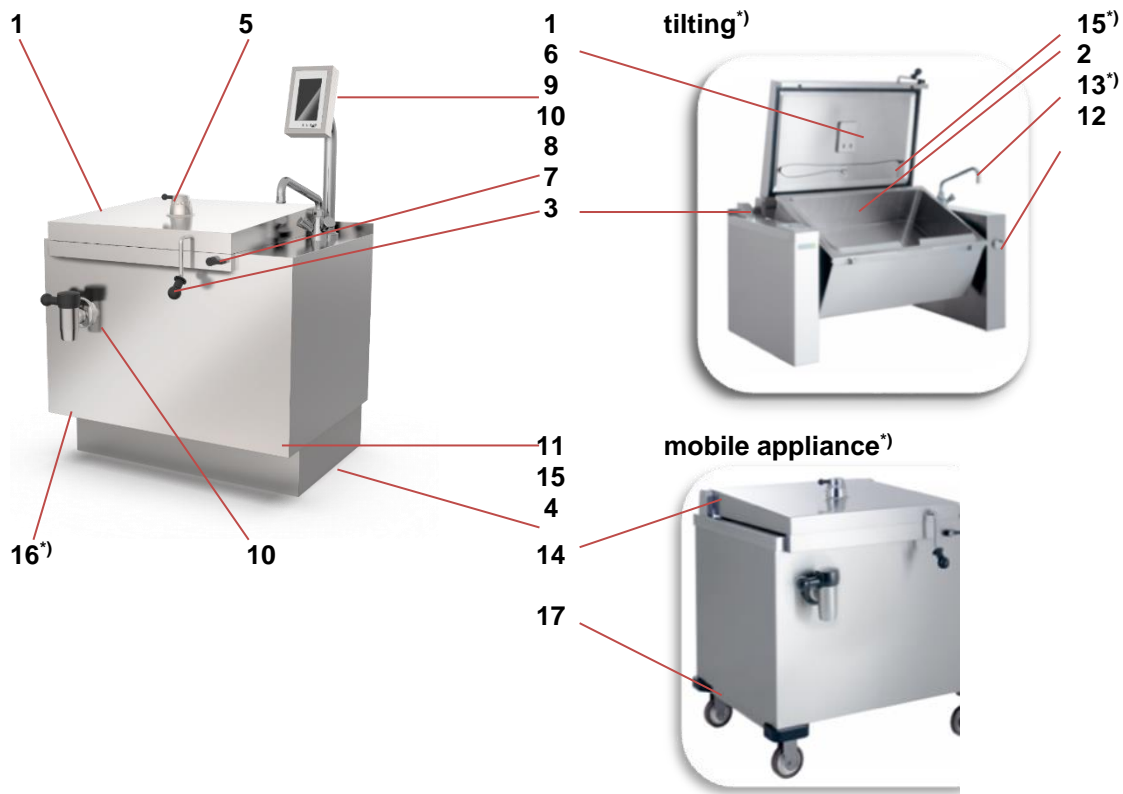

- 1. Appliance lid
- 2. Pan/Cooking chamber
- 3. Console
- 4. Base
- 5. ELRO multifunction valve^{*)}
- 6. Deflector plate^{*)}
- 7. Lid handle
- 8. Handle ELRO safety lock system^{*)}
- 9. Display control 90
- 10. ELRO drain valve, for tilting appliances^{*)}
- 11. Engraved appliance number (5 digits)
- 12. Control for tilting device^{*)}
- 13. Mixer tap^{*)} / WDS Water Dosing System^{*)}
- 14. Hygienic hinge
- 15. Core temperature probe^{*)}
- 16. Safety valve^{*)}
- 17. Fixed and steering castors^{*)}
- 18. Autolift (Pastamat; Fritomat)^{*)}



^{*)} Options













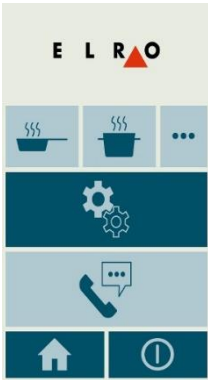



4 ELRO Quick Cook Select QCS

ELRO QCS ensures easiest operation and reproducibility. You use the appliance with the help of coloured touch display control 90. You can prepare food using operation modes or cooking programs. Individualize the control system according to your needs and habits.

If you set your preferred temperatures, activate automatic preheating in the roasting mode when switching on the Control Unit. Create your own cooking programs.

4.1 Main Menu – Operation Modes – Work and Setting Ranges

When the appliance is put into operation for the first time, you are in the roasting*) or cooking mode. Touch the symbol  to enter the main menu.

	MAIN MENU		OTHER
	 Roasting*) 30°-250°C		
	 Cooking 30°C-Boiling Point		 Pressure cooking*) 103°C-106°C
	 Other		 High-speed*) no
	 Settings		 Shallow float-frying*) 30°-190°C
	 Contact		 Cook book
	 Main Menu		 back
	 Switch Off		
			*) Options

4.1.1 Working with the QCS

The philosophy of the QCS Touch is intuitive and the same in all operating modes. Depending on the equipment / options of the device, various functions are available.

Set / Change Settings

-temperature / boiling level / time

Preheating / Horn

Options

-WDS^{*)} / Pastamat^{*)} / start time / Core temperature^{*)}

Settings

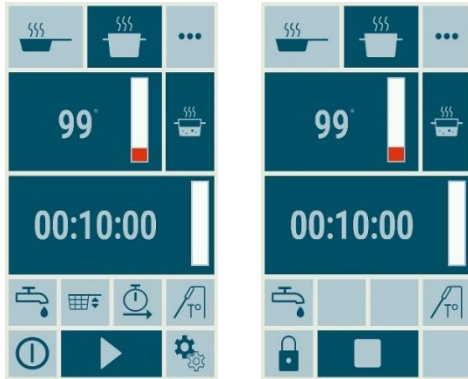

Optitherm Boiling level

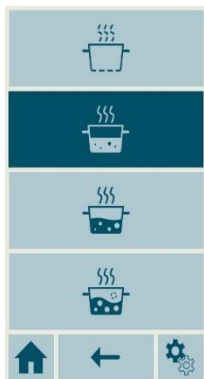

Optitherm Cooking

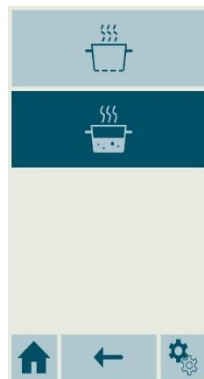

Keypad lock



Keypad lock:
In the settings you can define whether you want to activate the keyboard lock and after what time this should happen.

Heating up:

The bar shows the progress of the heating. Before reaching the set temperature, the bar changes from **RED** to **GREEN**. When the temperature is reached, the display flashes and the signal sounds (unless deactivated in the settings).

Heating up

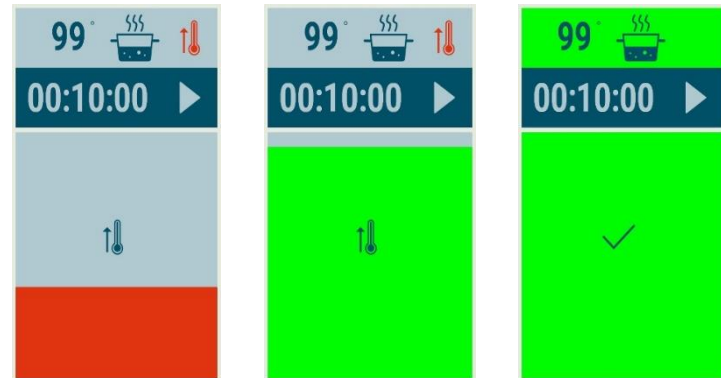

Process ready, press to start



End of process

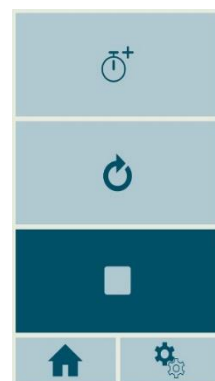

Add time

Repeat

Stop

Main menu

Add additional time at the end of the process

Repeat process at the end of the process

Process stop

Settings

4.1.2 Temperature

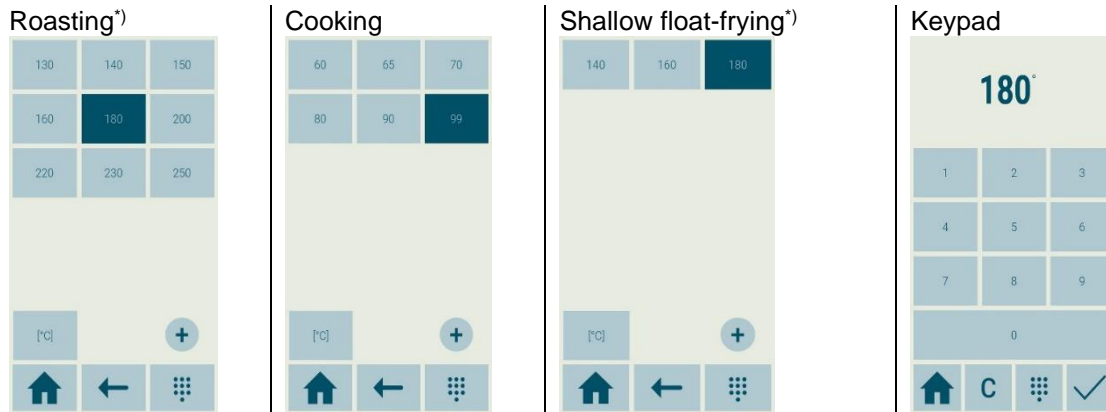

- Add default temperature
- Keypad, enter the required temperature
- Delete the input
- back to the preset temperatures
- Confirm / Apply

If you want to add a temperature, press , enter the required temperature.

If you want to delete or change a temperature in the preset temperatures, press the temperature to be changed with your finger for approx. 3 seconds. Press and , or enter a new temperature and confirm with .

If you do not want to work with the preset temperatures, you can enter the desired temperature with the keypad . Press to accept the entered temperature.

4.1.3 Time

--:--:-- means continuous operation, press and .

Default times

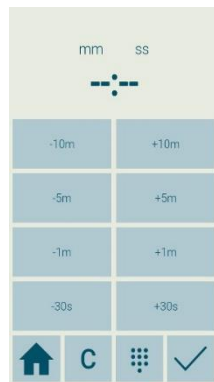

Keypad

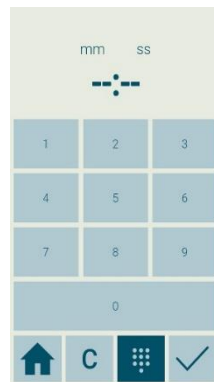

For the time you can choose between default times (+/-), or the keypad. Confirm with .

4.1.4 Boiling level – Operation mode cooking

In the Cooking at boiling temperature operating mode, select the following wall levels (cooking intensity):

little – medium – high

4.1.5 Optitherm

Select the Optitherm function in the Cooking mode if you want to prevent delicate foods (e.g. milk, rice pudding, polenta, fondue) from burning.

4.1.6 Start time

Enter the time at which the appliance must heat up.

4.1.7 WDS Water dosing system^{*)}

Cold water
Input via preset filling quantities

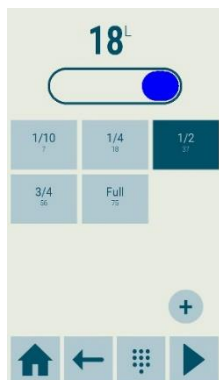

Warm water
Individual input

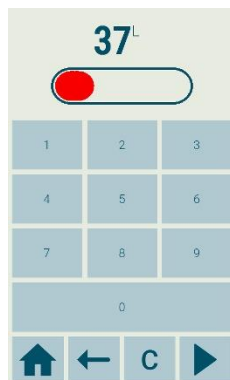

Mixed water
Individual input

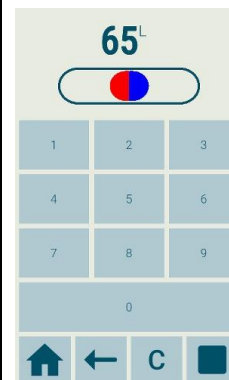

Set the desired amount of water. Choose between cold, warm or mixed water. Start the water outlet .

If you want to stop the water outlet, press  again.

4.1.8 Core temperature probe^{*)}

If the appliance is equipped with a core temperature probe, you can activate it. The core temperature is now displayed instead of the process time. Entering the core temperature is identical to entering the temperature.

The 6-point core temperature probe makes cooking to the precise degree easy.

👉 Make sure the probe is placed in the middle of the food.

4.1.9 Autolift^{*)} – Autolift Fritomat^{*)} – Autolift Pastamat^{*)}









Process/Charge completed ⇌ You can restart the process/Charge 

👉 Horn inactive ⇌ Observe the display.

Load the basket holder with baskets and press . The baskets are lowered into the cooking chamber and the set time begins to run.

After the time has elapsed, the Autolift lifts the baskets out of the cooking chamber. The horn sounds and the process status display flashes.







4.1.10 Procedure Vital pressure cooking with/without High-speed*)

1. Insert bottom plate  , switch on the control. Chose in the main screen the operation mode  
2. Fill the cooking chamber with water  (cover the bottom with 2-3cm water)
3. without Speed appliance cold ⇒ 
with Speed  appliance cold ⇒ option High-speed  and start 

Tip: When preheating, close the lid, but with the ELRO multi-function valve open. 

4. Horn sounds (if active) - Display blink green
5. Acknowledge this message by touching the display
6. Place the products to be cooked in the perforated GN baskets 1/1-150
7. ⚠ We recommend using GN baskets 1/1-100 for finely cut deep-frozen and fresh products
8. Hang the GN baskets in the cooking chamber or place them on the bottom plate
9. Make sure that the bottom plate is correctly mounted

Close the appliance lid with opened ELRO multifunction valve 



10. Lock the ELRO safety lock system ⇒ OPEN  / CLOSED 
11. Close the ELRO multifunction valve 
12. Start the process 
13. Signal pin rises out of the ELRO multifunction valve as soon as pressure has built up in the cooking chamber 
14. At the end of the pressure cooking process, lid cooling is activated. Pressure in the cooking chamber is released 
15. Horn sounds (if active) – Display blinks in green.
16. Acknowledge this message by touching the display.

 **CAUTION**

Lid cooling may be reactivated by escaping steam.

17. Open the ELRO multifunction valve **slowly**. The cooking chamber is aerated, and the pressure released. 



The red signal pin disappears into the ELRO multifunction valve

18. Open the safety lock ⇒ CLOSED  / OPEN 
and then the appliance lid

 **CAUTION**

At first, only open the lid a few centimetres because the food could overflow. In this case close the lid and wait until foam has settled.

4.1.10.1 Aborting a cooking process

Tap the display. This will take you to the set process data. During the pressure cooking process, press the lid cooling button  or the process is aborted .

4.5.10.2 Pressure cooking processes in batches

Make sure there is enough water in the cooking chamber after each batch.

4.2 Basic preparation modes in the ELRO QCS cookbook

The ELRO QCS cookbook features easy access to basic preparation modes with predefined, process-proven values to guarantee optimal cooking results. These fixed programs are marked with a * before the cooking programs names. You can use these fixed cooking programs as a basis for your own cooking programs. To do so, modify the settings (temperature, time, options, phases, etc.) and save the cooking program under a new name.

Here you can change, create and save cooking programs in the cookbook.

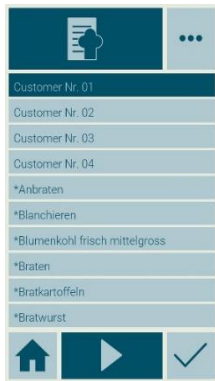

Cooking programs, in alphabetical order

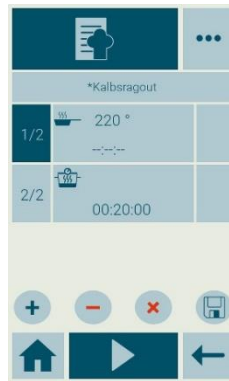

Cooking program



Phase 1/2

Phase 2/2

Create, editing, saving

4.2.1 Create, Editing and saving cooking programs



Select an existing cooking program. Make the required changes in the individual cooking phases.

-  add cooking phase
-  delete cooking phase
-  delete cooking program

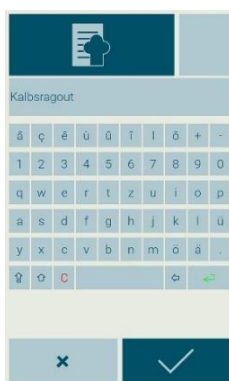

To save the changes or delete cooking programs, you need the corresponding user code. Read the chapter "Settings - User code" in this manual.



If you want to save the cooking program, press , you will be asked whether you want to save the changes. Enter the desired program name using the keyboard and confirm with .

4.3 Chef to Chef

Please visit our homepage www.ELRO.ch. Under the heading Chef to Chef, you will find practical tips and information.

4.3.1 Slow overnight cooking

Many products are very well suited for slow overnight cooking. This increases production performance, decreases energy costs, improves product quality, reduces weight loss and saves time!

Boiled beef etc.

Blanch the meat briefly, and then cover with fresh water.

Add some root vegetables.  **Attention: do not add salt** (the meat will turn red)! Close lid, select the fixed cooking program  ***Slow overnight cooking**.

Start process 

Roast beef, braised beef, etc.

Brown meat, cover with stock, close lid.

Fixed cooking program  *** Slow overnight cooking**.

Start process 

Stocks, bouillon, basic sauces

Prepare stocks or basic sauces.  Distribute bones, etc. in GN baskets for easy removal on the following day. Bring sauces, stocks to a boil and skim off fat.

Fixed cooking program  *** Slow overnight cooking**

Set temperature at 90°C, start process .

4.3.2 Cooking with Optitherm

Thanks to this function thick, pasty and difficult to heat food can be cooked optimally. Optitherm prevents food from building up or scorching on the basin bottom.

Polenta, rice pudding, semolina pudding, etc.



Fixed cooking program  ***Boiling**.

Boil at 98°C with Optitherm  (blinks when in operation), Horn
Add liquid (milk, stock, etc.).

Start process . Before the liquid reaches the boiling point, the horn will sound, acknowledge.

Select boiling level , start process .



Stir liquid and quickly bring to a boil. Add polenta, rice pudding or semolina and stir well.

Stop process , set temperature to 94°C and the cooking time to 30-40 minutes, start process .

Cream/Pudding

Fixed cooking program  ***Boiling**

Boil at 98°C with Optitherm  (blinks when in operation), Horn

Add liquid (milk without sugar), start process . Before the milk reaches the boiling point, the horn  will sound. Acknowledge

Boiling level , start process .

Bring the milk to a boil quickly while stirring continuously. Add the pudding powder with sugar, let steep , do not let the mixture cook further

 Stop the process and fill the pudding into bowls.

4.3.3 Standard cooking times

It is possible to steam different vegetables together in the ELRO pressure bratt pan without taste transfer. Temperatures vary according to loading quantity and product (fresh or deep-frozen products). ☺ For deep-frozen products, the cooking times are reduced by 50%.

Cooking requirements for restaurants and catering to the elderly differ.

Roasting		Temperature [°C]
Browning meat (minced meat, ragout, braised beef, Bolognaise)		220 - 250
Cutlets, meat roulades, steaks, escalopes, veal knuckles		180 - 220
Filets of fish		175 - 190
Pancakes		190 - 200
Pasta, Spätzle, Knöpfli, Schupfnudeln (finger-shaped potato dumplings)		200 - 220
Semolina, corn pancakes		130 - 180
Fried sausages		160 - 225
Fried potatoes, Rösti (hash brown potatoes)		220 - 230
Fried eggs		130 - 150
Fresh vegetables Vital pressure cooking	Catering to the elderly [min.]	Restaurants [Min]
Diced boiled potatoes	10 - 15	6 - 8
Whole potatoes, in their jackets (depending on size)	20 - 30	12 - 20
Cauliflower flowerets	6 - 10	3 - 5
Carrots whole	10 - 15	8 - 10
Carrots cut up	5 - 10	3 - 5
Kohlrabi cut up	5 - 10	3 - 5
Celery cut up	5 - 8	3 - 5
Beetroots whole	50 - 70	30 - 50
Cabbage (Savoy)	15 - 20	10 - 15
Green beans	5 - 10	3 - 5
Fennel whole	20 - 30	15 - 30
Fennel cut up	8 - 12	5 - 8
Belgian endives whole	15 - 20	10 - 15
Stew Vital pressure cooking	Catering to the elderly [min.]	Restaurants [Min]
Beef ragout	45 - 55	30 - 40
Pork knuckles cut up	30 - 45	25 - 35
Veal roulades	20 - 30	15 - 20
Minced veal 2nd grade	15 - 20	10 - 15
Turkey goulash	15 - 25	15 - 20
Beef escalope	25 - 40	25 - 35
Stewed beef	75 - 90	60 - 90
Venison ragout	30 - 45	25 - 35
Roast pork (neck)	60 - 90	60 - 75
Pork ragout	30 - 45	25 - 30
Veal shoulder	60 - 80	50 - 65
Chicken legs	25 - 35	15 - 25
Lamb knuckles cut up	30 - 40	25 - 30
Leg of lamb	60 - 85	50 - 75
Vital pressure cooking - core temperature standard values		Temperature [°C]
Poultry		75
Pork neck		80
Pork back		73
Braised beef		90
Braised veal shoulder		72 - 75
Leg of lamb		70 - 75
Shallow float frying		Temperature [°C]
Potato croquettes		160 - 190
Spring rolls		160 - 190
Fish, shell fishes, seafood		160 - 190
Vegetables, mushrooms		160 - 190
Pancakes		160 - 190
Donuts		160 - 190
Fruits		160 - 190

4.3.4 Production capacity

Production capacity roasting¹⁾	The maximum production output per hour (e.g. goulash, ragout, minced meat)				
Capacity up to max. filling mark [l]	53¹ / 56²	71¹ / 75²	93¹ / 97²	108¹⁾ / 113²	142¹ - 147²
Max. volume [kg] per batch	6	10	10	15	15
Max. production [volume per hour]	24	40	40	60	60

Production capacity pressure cooking¹⁾	The maximum production output per hour (e.g. quartered potatoes)				
Capacity up to max. filling mark [l]	53¹ / 56²	71¹ / 75²	93¹ / 97²	108¹⁾ / 113²	142¹ - 147²
Max. volume [kg] per batch	10	20	20	30	30
Max. production [volume per hour]	20	40	40	60	60

Production capacity	The maximum production output per hour (e.g. apple fritters, spring rolls)				
Capacity up to max. filling mark [l]	53³ / 56⁴	71¹ / 75²	93¹ / 97²	108¹⁾ / 113²	142¹ - 147²
Max. volume fat [l]	39l/34kg	52l/45kg	52l/45kg	65l/56.5kg	65l/56.5kg
Min. volume fat [l]	17l/15kg	23l/20kg	23l/20kg	34l/29.5kg	34l/29.5kg
Max. volume [kg] per batch	3.5	7	7	10.5	10.5
Max. production [volume per hour]	14	28	28	42	42

¹ DBGN, M-DBGN, DBGNI, M-DBGNI, DBGNS, M-DBGNS

² DBKGN, M-DBKGN, DBKGS, M-DBKGS

³ DBGN, M-DBGN, DBGNI, M-DBGNI, DBGNS, M-DBGNS

⁴ DBKGN, M-DBKGN, DBKGS, M-DBKGS

4.4 ELRO Drain valve



Allows complete draining of the cooking chamber. It prevents filling when the appliance has been improperly installed, as well as accidental opening through jolting or knocking.

The ELRO drain valve^{*)} is an option for tilting appliances.

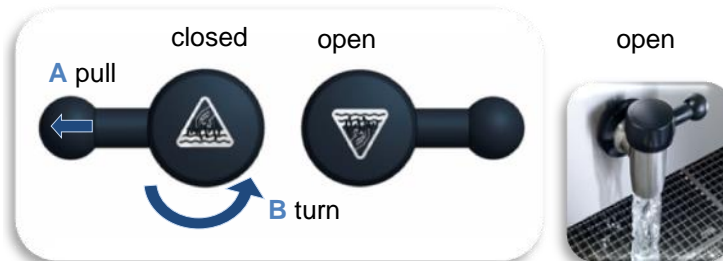

CAUTION

Remove the valve piston (1) of the ELRO drain valve only when the appliance lid is open!

CAUTION

The ELRO drain valve becomes hot during operation!
Always use the foreseen handle when operating the drain valve.

WARNING

When draining the cooking chamber, hot liquids or escaping steam can cause scalding/burning. Stand back when opening the ELRO drain valve.

4.4.1 Cleaning

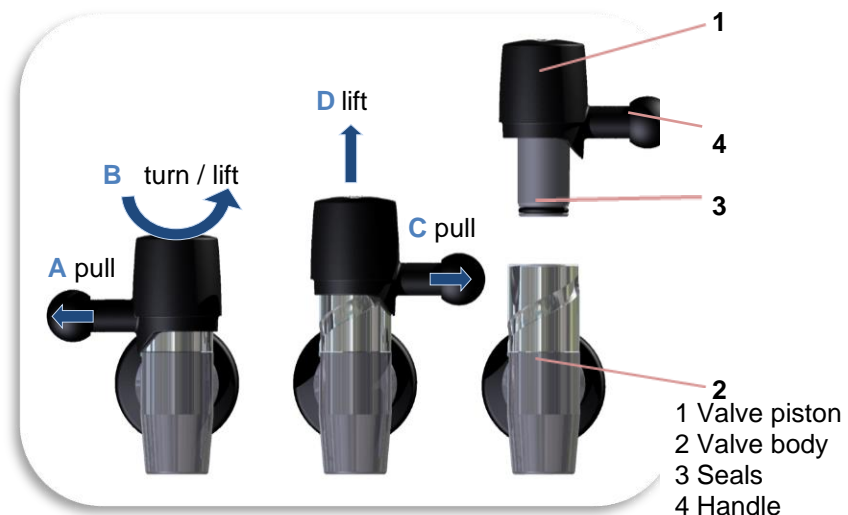

After each use, clean the valve piston (1) and body (2) with commercial detergents.

4.4.2 Maintenance

CAUTION

After each use/cleaning, check

- ☞ proper functioning
- ☞ if parts are damaged and
- ☞ piston seals (3) for tears or cuts.

If the valve is not functioning correctly or if parts are damaged, contact ELRO After Sales Service.

Lubricate the valve piston (1) with Vaseline or glycerine before you insert it in the valve body (at least once a week).

4.5 ELRO multifunction valve



- 1 Valve upper body
- 2 Signal pin I or II
- 3 Deflector plate
- 4 Appliance lid
- 5 Coupling ring
- 6 Handle

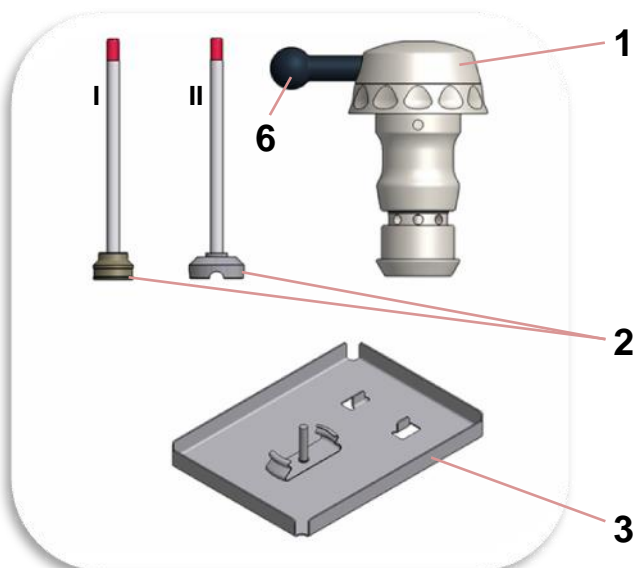
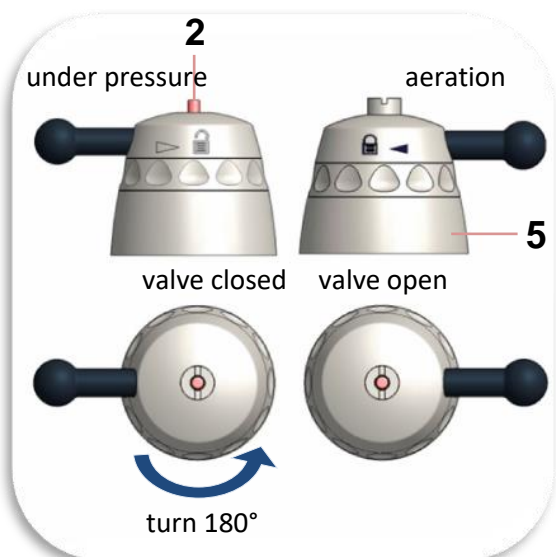

CAUTION

Deflector plate (3) must be correctly mounted during operation!
If you place food in boiling or vacuum bags, please arrange them so they do not clog the deflector plate (3).

CAUTION

The correct signal pin (2) must be inserted!

Signal pin I for: DGN, DGNS, DBGN-EDS, DBGNS-EDS, DBGNI-EDS

Signal pin II for: DBGN-ED and DBKGN-ED

The ELRO multifunction valve becomes hot during operation. Use the foreseen handle.

WARNING

The ELRO multifunction valve can be activated automatically or manually during operation. In both cases hot steam escapes from the steam outlet opening! Never place hands or head in front of or over this opening when the appliance is in operation.

4.5.1 Cleaning

	Valve upper body (1)	Signal pin (2)	Deflector plate (3)
After each use		X	X
Weekly	X		

Procedure:

Valve is open, open appliance lid (4).

Pull off the deflector plate (3), take out the signal pin (2).

Close the appliance lid (4) and screw off the coupling ring (5), remove the valve upper body (1).

Clean the valve upper body (1), deflector plate (3), signal pin (2) under running water.

Assemble the ELRO multifunction valve in the reverse order.

4.5.2 Cleaning

CAUTION

Regularly check the proper functioning of the ELRO multifunction valve and if parts have been damaged. If this is the case, do not put the appliance under pressure and contact ELRO After Sales Service.

4.6 ELRO safety lock system



- 1 Lid handle
- 2 Handle
- 3 Appliance lid

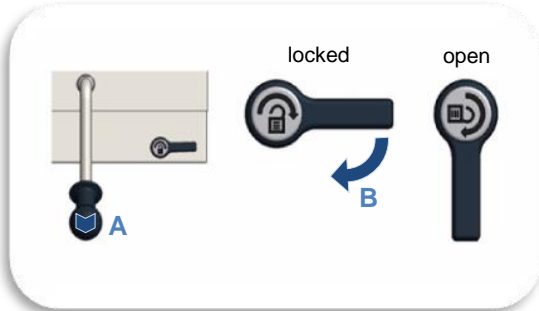

Open appliance lid:

- A** Press down lid handle (1) with left hand
- B** Press down the handle (2) to 90°C with right hand

CAUTION

Never put the appliance under pressure if the ELRO safety lock system is malfunctioning. Inform ELRO After Sales Services immediately. Never open the pressure lid with force.

CAUTION

Danger of scalding! Before opening the appliance lid, make sure the cooking chamber is pressure free. To do so, please refer to the ELRO multifunction valve red signal pin.

CAUTION

At first, only open the lid a few centimetres because the food could overflow. In this case close the lid and wait until foam has settled.

CAUTION

The ELRO safety lock system becomes hot during operation. Use the foreseen handle.

CAUTION

When closing the appliance lid, make sure that the space around the cooking chamber is free so that no objects/extremities are in the way when closing the lid.

4.6.1 Cleaning

Clean the ELRO safety lock system with commercial detergents. Before use, read the detergent instruction leaflet.

4.6.2 Maintenance

CAUTION

Check proper functioning. In case of malfunctioning, please contact ELRO After Sales Service.

4.7 Autolift*)

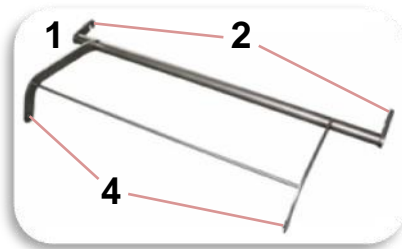

- 1 Frame holder
- 2 Frame holder clip
- 3 Basket holder
- 4 Basket holder clip
- 5 Frame holder cam
- 6 Basket holder cam
- 7 Slide guides
- 8 Basket holder edge

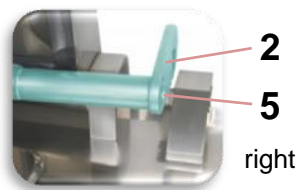
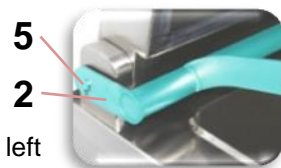
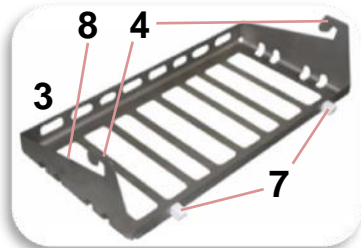

Open the appliance lid. The Autolift is positioned slightly below the upper stopper. Insert the frame holder clip (2) from left to right over the cam for the frame holder (5).



Place the basket edges (8) on the left and right onto the frame holder cams.

Press along the basket holder edges (8) until the basket holder clip (4) is inserted in the basket holder cam (6). Lower the basket holder (3) into the cooking chamber. The slide guides (7) must lie against the basin wall.

Make sure that the frame holder (1) and the basket holder (3) are securely mounted. Load the GN baskets into the basket holder.

Lift or lower the GN baskets into the cooking chamber with . Stop the

Autolift, by pressing again .

4.7.1 Batches

CAUTION

CAUTION

CAUTION

Actuate , the Autolift lowers the baskets into the cooking chamber. After the set time has elapsed, the horn sounds if activated and the display flashes. The baskets are lifted out of the cooking chamber. During this time, the horn sounds at regular intervals and the display flashes.

Touching the Autolift components can cause burning. Always use appropriate protection (e.g. gloves) when handling GN baskets and frames during and after the cooking process.

Regularly check the slide guides (7) for wear and tear. If wear and tear is heavy the slide guides (7) must be replaced to avoid scratching of the cooking chamber at next use.

Limbs or objects can be pinched in the moveable parts of the Autolift and the cooking chamber. Make sure that all areas are free before operation.

4.8 Tilting*)

easy-tilt



easy-tilt electronic*)



Open the appliance lid.

Turn the manual wheel (1) or the rotating wheel (2) in the desired direction to tilt the cooking chamber.

If you start a process, or a process is active and is tilted and the cooking chamber is not in the horizontal position, you will see the adjacent system message.

Operation is only possible when the cooking chamber is in the horizontal position. Adjust the tilting speed to the filling level. Ensure that the front edge of the cooking chamber is not subjected to any additional load during tilting. There is a risk of scalding from hot food.

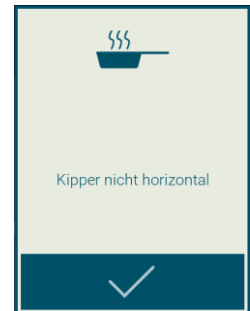

During tilting limbs or objects can be pinched or squashed in the area between the basin and the console. Make sure this area is free before operation.

Danger of burning! Accidental or jerky tilting can cause food or fat to overflow.

4.9 ELRO PMS, Power Management System

With the ELRO PMS (**P**ower **M**anagement **S**ystem), you can reduce **energy and installation** costs. Three to twelve appliances can be connected to a PMS system. The appliances share the specified total connected load amongst each other. The result is a 30% reduction of the connected load of the appliance group.

You can tell which appliance is being operated with reduced connected load for a short time (PMS active) by the flashing temperature symbol on the display of control 90. Note that with PMS the heating may be off for a short time.

You can identify the appliance being temporarily operated with a reduced connected load (PMS active) thanks to the blinking temperature symbol on the display. Please note that with PMS, the heating system can be temporarily switched off.

When the power supply and/or the communication line of an appliance in the PMS group was interrupted for two weeks (14 days), error 26 appears on all appliances in the PMS group when they are switched on. You must acknowledge this message. Then you can start operating the appliance as usual. It is recommended to have the data line be checked by the responsible person (IT department, electrician) to make sure that the total connected load for the PMS group is not exceeded.



**PMS: Datenbus
überprüfen!**



4.10 Power limitation system LBS*) on site

This appliance can be prepared for connection to an external LBS system*). The aim of such a system is to reduce electrical power consumption. Time-staggered release of the output connections for appliances with high connection values prevents exceeding of the average maximum permitted connection value for an object (e.g. kitchen) within a given measurement period (e.g. 15 minutes). You can identify LBS system*) intervention thanks to the blinking temperature display on control 90. Please note that with LBS*), the heating system can be temporarily switched off. In order to avoid unnecessary deterioration of appliance control modes, please adhere to the standard values established in the General Remarks/Installation Plan for heating systems – minimum switch on and maximum switch off time.

4.11 Mobile appliance*)

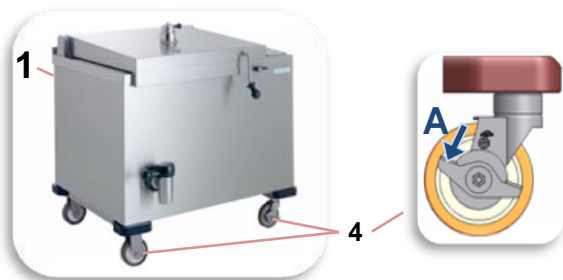

- 1 Appliance back side
- 2 Protection hood
- 3 Appliance cable clamp
- 4 Steering and locked castors
- 5 Mains supply

4.11.1 Initial operation

Operate the appliance only on a level floor. When placed on a sloping floor, the appliance must be levelled out with an underlay. Position the appliance correctly. Avoid accidental shifting of the appliance. Lock (A) the steering castors (4).

4.11.2 Connection

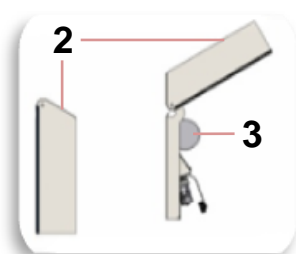

Open the protection hood (2) on the appliance back side (1). Connect all media connections to the mains supply (5). You can start the appliance.

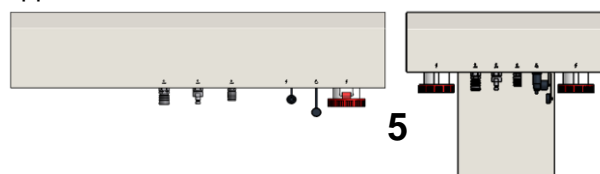

4.11.3 Disassembly



CAUTION

Put the appliance in the horizontal (level) position and close the appliance lid.

(A) Turn off the appliance. Empty the cooking chamber.

Never move the appliance with hot food!

Remove all media connections. **Never pull the plug out of the socket with the cable.** Install the connection cable. Place the connection cable in the clamp (3). Make sure that cables and hoses are stored so that they are not rolled over when moving the appliance. Unlock the steering castors (4).

Move the appliance with caution and with the greatest care! **Never pull the appliance with the cable.** Make sure that there are no persons or objects in the way when moving the appliance on a sloped floor. Always move the appliance with the help of a second person.

4.11.4 Cleaning

Refer to the chapter Cleaning in this instruction manual.

4.11.5 Maintenance

CAUTION

Make sure the media connection cables (electricity, water, steam) are never under tension. These should never be exposed to traction!

If the connection cable/hose has been damaged in any way (squashed or cut), the appliance may not be put into operation. The connection cable/hose must be replaced! The replacement cable must correspond with the original one. In addition the cable type must be suitable for use in professional kitchens (temperature, oil resistance). Check the steering and locked castors (4) functions on a regular basis.

4.12 Filter control*)

Soft water must be used for lid cooling. If soft water is not available, the appliance can be operated with a water softener (filter). Make sure that only water for the lid cooling flows through the filter and that ONE filter is installed per appliance!

The customer is responsible for the water quality.



4.12.1 Filter factory setting

This filter has a **water hardness 28dH** (carbonate hardness in °KH) and a **filter capacity** for a total hardness of 28°KH (partial desalination): 3750 litres are preset.

If another filter is used, the filter capacity must be determined according to the filter manufacturer's instructions (table / diagram) taking into account the **water hardness**. Generally, a distinction is made between complete desalination (total hardness in °GH) and partial desalination (carbonate hardness in °KH).

5 Cleaning

Please refer to and follow the cleaning procedure presented in the previous chapters. This ensures the reliable functioning of the appliance.

This appliance is made of high-grade stainless steel. For the cleaning, use mild, commercial detergents, soft cloths or brushes. Use the detergents according to their instruction leaflet. Do not use metal objects or other items which can scratch, corrode or cut the surface.



Lid seal

Clean the appliance only when it has cooled sufficiently. Empty the cooking chamber completely, and dry with a cloth.

Make sure that there is no fat in the basin before cleaning.

Do not damage the seal during cleaning. Only use nonabrasive tools or cloths. Check the seal for tears and cuts. If the seal is damaged, it must be replaced by ELRO After Sales Service.

After appliance cleaning, lubricate the dry, detergent-free seal with glycerine.

5.1 ELRO High Pressure Cleaning HPC

It is possible to clean the appliance with a high pressure cleaner under the following conditions.



Turn off the appliance with  (A) 4 seconds, and empty the cooking chamber. Take into consideration that other kitchen appliances can be damaged during the high pressure cleaning process!



The mobile appliance must always be separated from mains supply (electricity, water, steam)! For mobile appliances, make sure that you never hold the high pressure jet **under the appliance** and **under the media connections protection hood!** The protection hood must be closed!



When cleaning the appliance, the plug must never be immersed or sprayed with water. Dry the plug after cleaning.



You can clean the appliance with high pressure from above and from the sides (never from below / behind)!

The following parameters must be observed:

- Maximum pressure 10'000kPa (100bar)
- Maximum water temperature 80°C
- Maximum water flow through rate 15l/min
- Minimum distance from appliance 150mm
- Flat jet nozzle $\geq 35^\circ$

5.2 Long non-use

If you do not use the appliance for a long time, leave the appliance lid open. You can lubricate the cooking chamber with a cloth.

6 Contact Information Settings

Push in the main menu . You can now proceed to the following settings:

- Contrast
- Language
- After Sales Service/Appliance information
- Appliance configuration

6.1 Contact - SW and HW, Software key

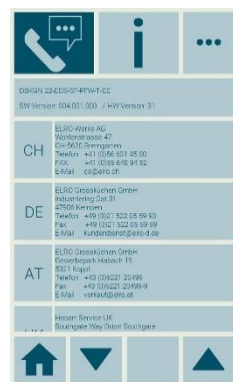
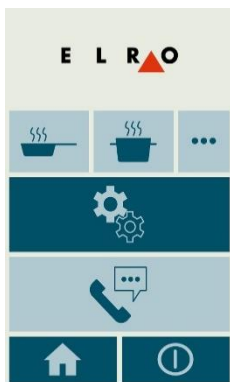

Here you will find all information on ELRO customer service.

In addition, you have the type of appliance and information about the installed hardware software version on the same screen.

6.2 Information – Appliance information

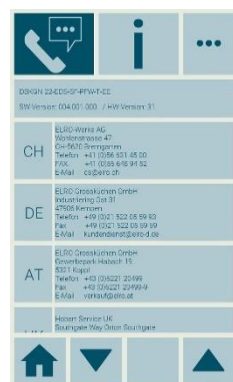
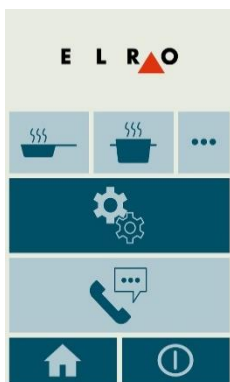







Type and Config		D81GN 224CDS5P4FW-EE	
SW-Version		044.001.000	
HW-Version		31	
HW-Nummer		156 / 540	
Temperatur Oberflache		20 °C	
Temperatur Hochdruckkammer		20 °C	
Temperatur Bodenteller		20 °C	
Temperatur Kammer		20 °C	
Temperatur Heizregister		20 °C	

Here you will find all information on ELRO customer service.

In addition, you have the type of appliance and information about the installed hardware software version on the same screen.

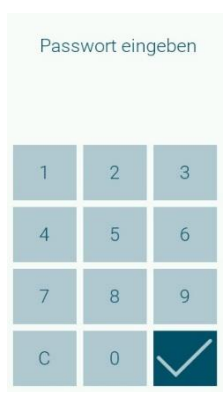
6.3 Settings – User code

 choose	 choose	
	<p>Display control 90 has various user codes.</p> <p>Choose </p> <p>Depending on the user code, the user has various rights:</p> <ul style="list-style-type: none"> • 2468 cooking programs • 2345 settings <p>Enter the user code. Confirm entry. After confirmation, the corresponding configuration menu for the user code is displayed.</p>	
	User Code: no	User Code: settings
	Language Contrast Date Time Activate summertime	 Appliance configuration SW-Version Error messages Keypad lock Standby Preheating Pan Default temperature roasting Default temperature cooking Default temperature shallow float-frying Default temperature core temperature High-speed always aktiv Signal

6.3.1 Preheating

In the settings, you can decide whether you want to preheat in the roasting mode after switching on the appliance.



Only preheat with a clean, dry cooking chamber bottom!

6.3.2 Signal

If the display blinks and/or the signal horn sounds, you must acknowledge this by touching the display, the signal horn stops.

You can deactivate the signal horn in the settings by selecting ___.

The signal horn sounds/display flashes, for example, when:

⇒  Preheating is finished ⇐ you can start the process 

7 Maintenance

When operating the appliance with a filter, the customer must make sure that the manufacturer's instructions (water hardness / filter capacity) are correctly entered in the appliance.

Otherwise, repairs and maintenance may only be carried out by ELRO After Sales Service or by service companies authorized by ELRO. In other cases, all guarantee and regress claims are invalid and the appliance may not be cleaned with high pressure (HPC) or a water jet.

This also applies to additions or adaptations which were not authorized by ELRO.

It is recommended to have your appliance checked for proper functioning every 4 years by ELRO After Sales Service.

Exception: Float-frying^{*)}, Fritomat^{*)}

An annual check must be carried out and safety components must be replaced every 8 years!



7.1 Filter capacity

The filter capacity is entered via the **user code „cooking programs settings“**. The following entries must be made at appliance commissioning or when the filter is changed: confirm the **filter capacity** and the **filter replacement!**

7.1.1 Filter replacement



Before reaching the filter capacity, a maintenance message is generated asking you to prepare for filter replacement. Replace the filter. Confirm replacement with the user code „cooking programs settings“. Press filter replacement – the filter capacity values are reset! When replacing the filter, check the filter capacity based on the filter manufacturer's data!



If you do not change the filter and the filter capacity is exhausted, you **CANNOT** start a pressure cooking process. You will be notified immediately with the adjacent error message. At the latest now you **MUST** carry out the filter change and its confirmation.

7.2 Calibrate Water Dosing System WDS*)

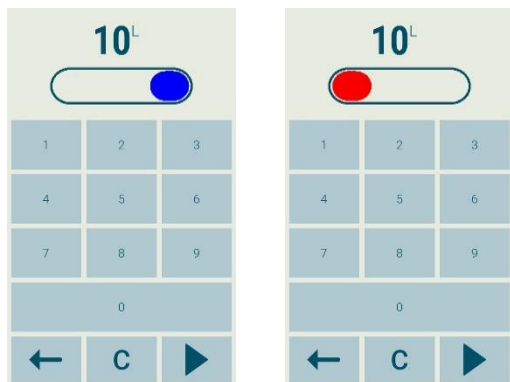

Cold water

Warm water

Function check

The quantity of water must be calibrated on site during installation!

Fill 10 litres of water into the measuring container
press ⇒ Cold water is calibrated.

Repeat if necessary.

Fill 10 litres of water into the measuring container
press ⇒ Warm water is calibrated.

Repeat if necessary.

Return to the main menu WDS

Set 10 litres. Check both cold and hot water!

Start WDS*)

Check the water volume flowing into the measuring container. Calibration is correct if the water volume is 10 litres +/- 0.2.

7.3 Error Message

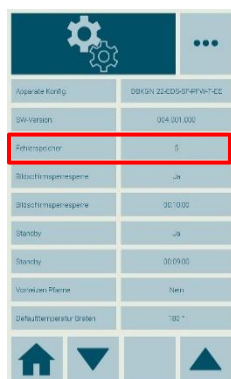

displays a list of error messages that have occurred.

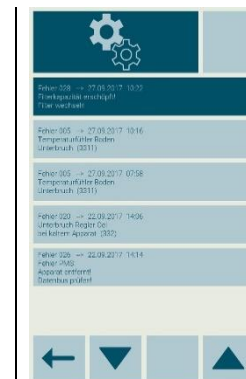

7.3.1 Finding errors, error diagnosis and repair

Write down the error message and conditions. This information is important for ELRO After Sales Service.

If the steam valve blows off steam continuously during a pressure cooking process or if the maximum temperature is not reached, this could indicate a faulty setting of the boiling point at the appliance location. If the boiling point setting on the appliance (i.e. the maximum temperature setting) at the location does not correspond with the actual boiling point, it must be corrected according to the installation instructions (chapter "Setting the appliance to the height above sea level").